

DHI-ARD1233-W2

Wireless PIR detector



- Pet immunity function.
- Auto temperature compensation.
- 3-level sensitivity adjustment.
- Low battery alarm.
- Anti-tampering.
- Temperature measurement.
- Frequency hopping function and two-way communication technology ensure communication stability.
- Cloud update and automatic recovery from update failure.

System Overview

Wireless PIR detector is a wireless motion detector that can detect if there is a human moving around the detector. It can detect human or large animals invading the armed area, and provides timely notifications of alarm events, acting as a monitoring mechanism.

Scene

Mainly applied for villas, shops, apartments, etc.

Technical Specification

Port

Indicator Light	1 × green alarm indicator
Button	1 × power button

Function

Tamper Alarm	Yes
Remote Upgrade	Cloud update
Search	Signal strength detection
Test Mode	Yes
Low Battery Alarm	Yes

Wireless

Carrier Frequency	433.1 MHz–434.6 MHz
Communication Distance	Up to 1,200 m (3,937.01 ft) in an open space
Communication Mechanism	Two-way
Encryption Mode	AES128

Frequency Hopping	Yes
-------------------	-----

General

Power Supply	CR123A battery
Power Consumption	Max. 75 mW
Operating Temperature	−10 °C to +55 °C (+14 °F to +131 °F) (indoor)
Operating Humidity	10%–90% (RH).
Product Dimensions	104.0 mm × 60.0 mm × 50.0 mm (4.09" × 2.36" × 1.97") (L × W × H)
Packaging Dimensions	135.0 mm × 98.5 mm × 56.8 mm (5.31" × 3.88" × 2.24") (L × W × H)
Installation	Wall mount
Net Weight	100 g (0.22 lb)
Gross Weight	170 g (0.37 lb)
Certifications	CE
Battery Life	4 years
Casing	PC + ABS

Temperature

Measuring Range	−15 °C to +65 °C (+18.8 °F to +149 °F) (indoor)
Measuring Precision	± 1 °C (± 33.8 °F)
Resolution	1 °C (33.8 °F)

Specification

Detection Mode	PIR
Sensor	Dual-element low-noise PIR sensor

Detection Range	12 m (39.37 ft) (90°) with installation height of 2.2 m (7.21 ft)
Detection Speed	0.3 m/s–3 m/s (0.98 ft/s–9.84 ft/s)
Pet Alarm Level	≤ 18 kg (39.68 lb)
Pet Immunity Level	2000 lx
Two-way Digital Temperature Compensation	Yes, no attenuation of detection distance in high temperature
Sensitivity	3 levels adjustable

Ordering Information

Type	Model	Description
Wireless PIR detector	DHI-ARD1233-W2	Wireless PIR detector

Installation

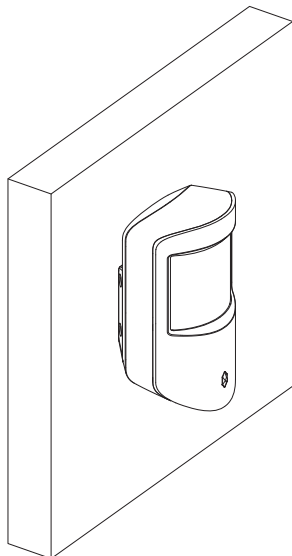

Dimensions (mm[inch])

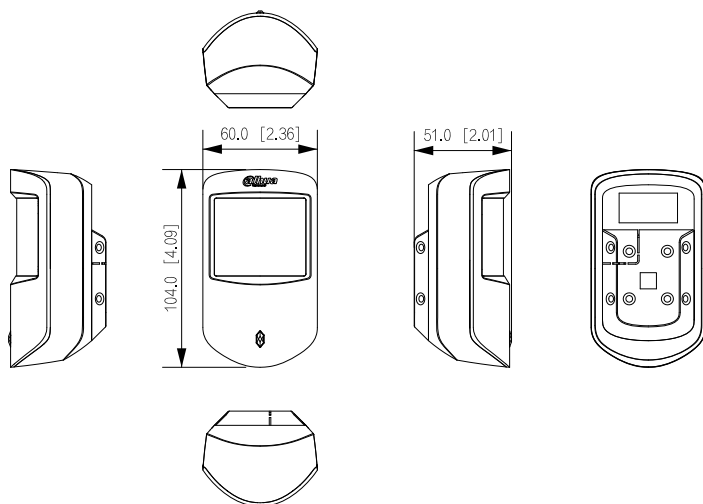

Application

